

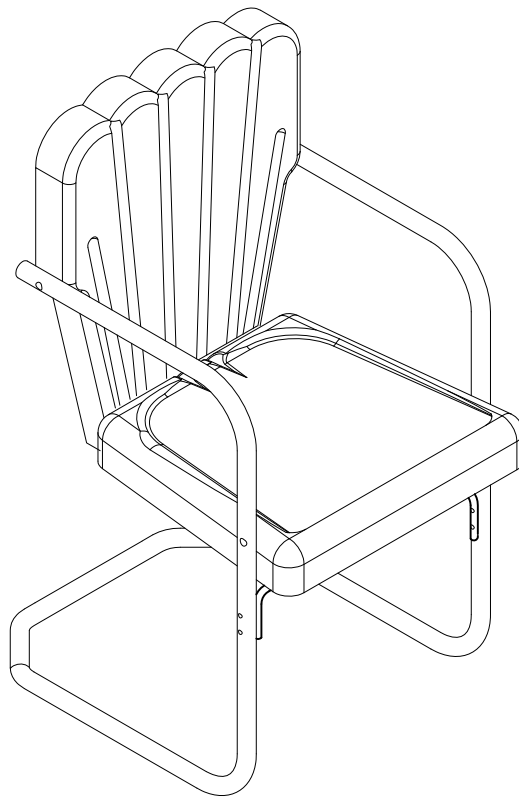

Metal Chair





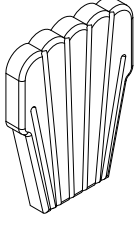
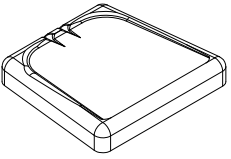
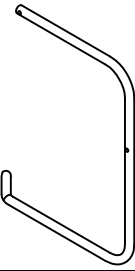
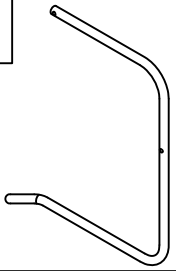
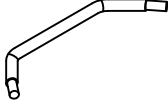
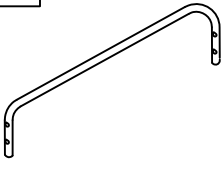

CO1031

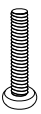

PART LIST

<p>A</p> 	<p>B</p> 	<p>C</p> 	<p>D</p> 	<p>E</p> 
<p>Chair Back 1 PC</p>	<p>Chair Seat 1 PC</p>	<p>Left Support Leg 1 PC</p>	<p>Right Support Leg 1 PC</p>	<p>Leg Connector 1 PC</p>
<p>F</p> 				
<p>Crossbar 1 PC</p>				

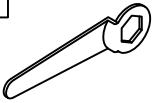
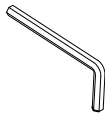
HARDWARE LIST

<p>#1</p>  <p>M6X40mm</p>	<p>#2</p>  <p>M6X38mm</p>	<p>#3</p>  <p>M6X13mm</p>	<p>#4</p> 	<p>#5</p> 
<p>Long Bolt 4 PCS (Extra 1)</p>	<p>Medium Bolt 4 PCS (Extra 1)</p>	<p>Short Bolt 3 PCS</p>	<p>Hex Nut 11 PCS (Extra 2)</p>	<p>Flat Washer 18 PCS (Extra 4)</p>
<p>#6</p> 	<p>#7</p> 	<p>#8</p> 	<p>#9</p> 	
<p>Wrench 1 PC</p>	<p>Allen Wrench 1 PC</p>	<p>Plastic Washer 4 PCS</p>	<p>Round Plastic Washer 8 PCS</p>	

NOTE: We recommend at least two people work together to assemble unit.

Step 1. Lay chair seat (part B) down on a soft flat surface, such as carpet, as shown below. Attach chair back (part A) to chair seat (part B) using short bolts (part #3), hex nuts (part #4), flat washers (part #5), wrench (part #6) and allen wrench (part #7).

NOTE: Please do not fully tighten bolts until unit is fully assembled.

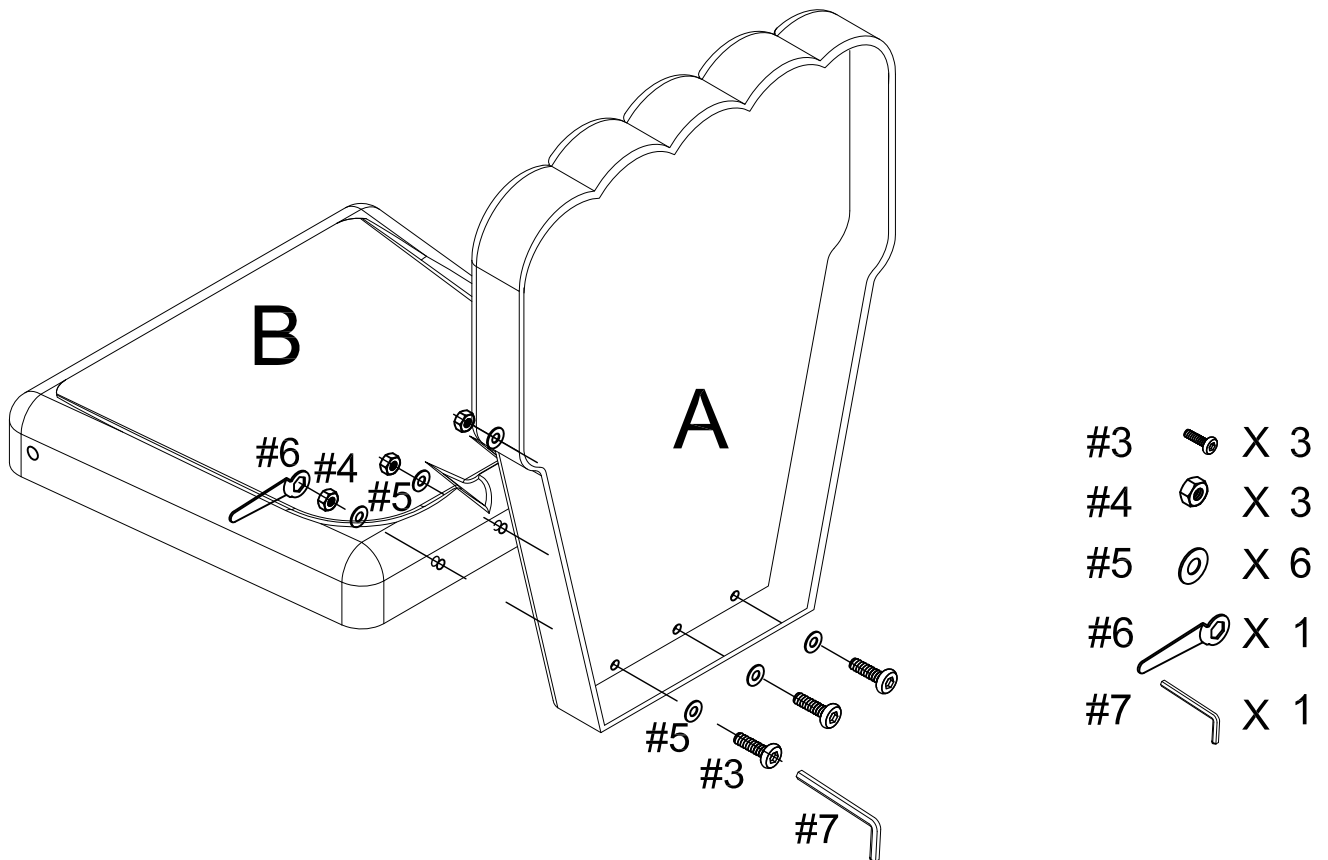

Step 2. Attach left support leg (part C) and right support leg (part D) to leg connector (part E).

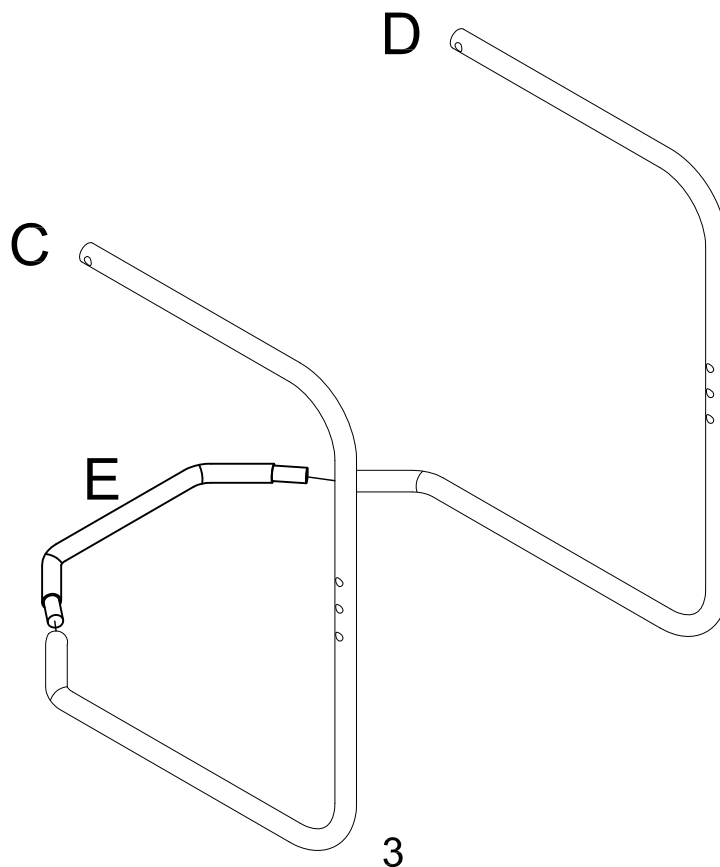

Step 3. Attach support legs (parts C & D) to chair back (part A) and chair seat (part B) using long bolts (part #1), Round Plastic Washer (part #9), hex nuts (part #4), flat washers (part #5), plastic washers (part #8), wrench (part #6) and allen wrench (part #7).



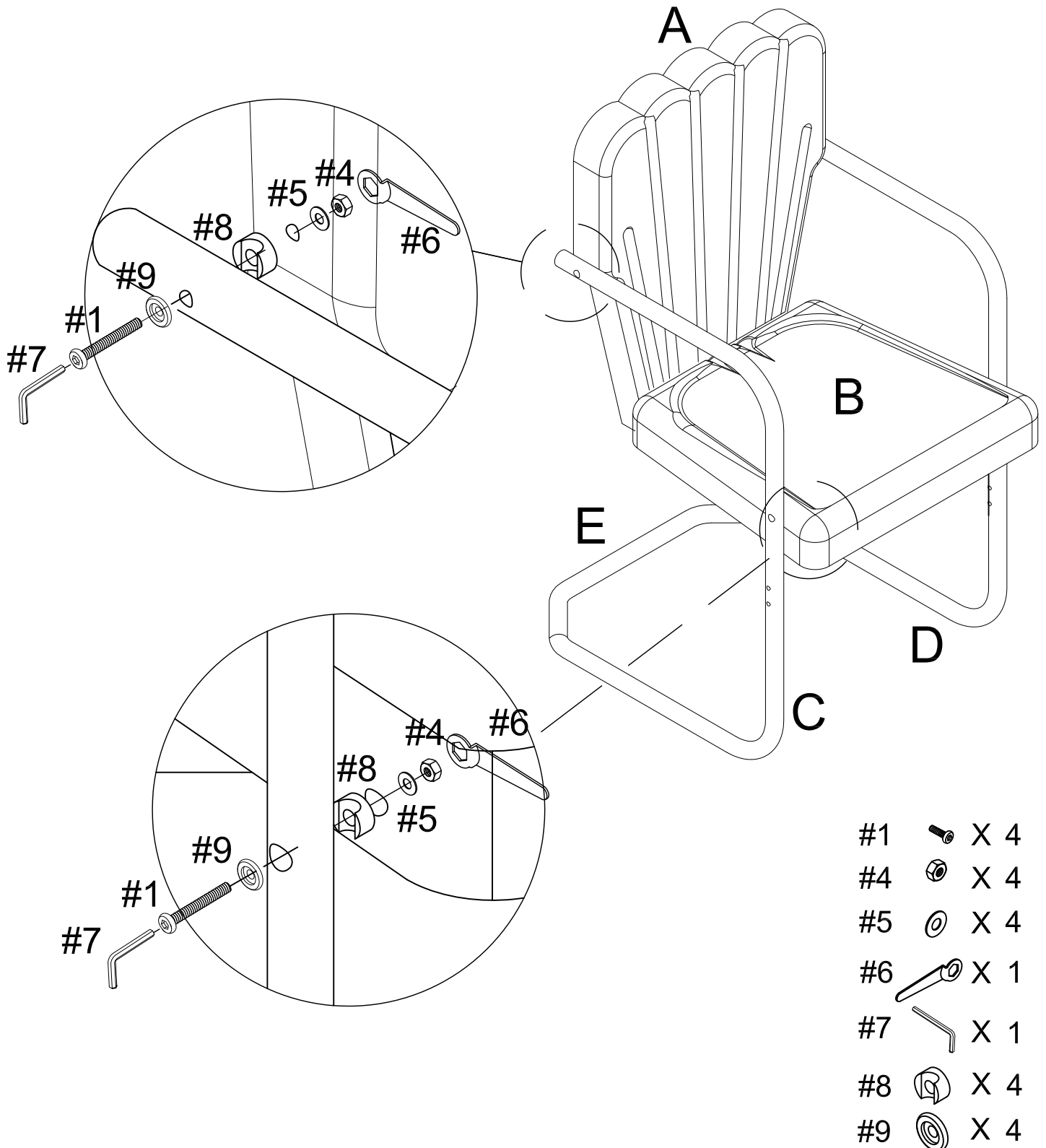



NOTE: Please do not fully tighten bolts until unit is fully assembled.

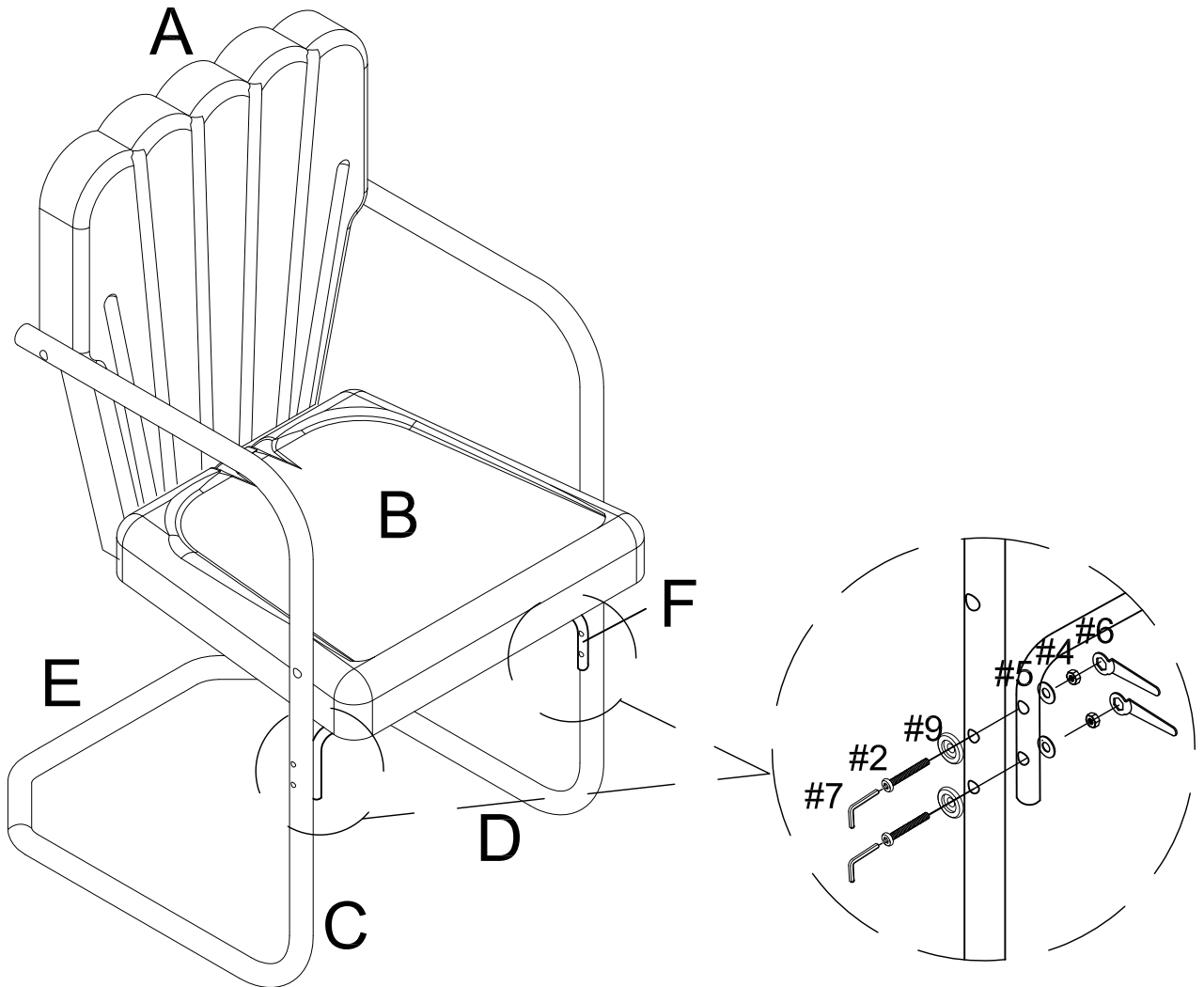

Step 4. Attach crossbar (part F) to left support leg (part C) and right support leg (part D) using medium bolts (part #2), Round Plastic Washer (part #9), hex nuts (part #4), flat washers (part #5), wrench (part #6) and allen wrench (part #7).

NOTE: Please fully tighten all bolts at this time.



- | | | |
|----|---|-----|
| #2 |  | X 4 |
| #4 |  | X 4 |
| #5 |  | X 4 |
| #6 |  | X 1 |
| #7 |  | X 1 |
| #9 |  | X 4 |